

# Safety Barrier Guidelines for Residential Pools

**Preventing Child Drownings**

U.S. Consumer Product  
Safety Commission



This document is in the public domain. Therefore it may be reproduced, in part or in whole, without permission by an individual or organization. However, if it is reproduced, the Commission would appreciate attribution and knowing how it is used.

For more information, write:

**U.S. Consumer Product Safety Commission**  
**Office of Communications**  
**4330 East West Highway**  
**Bethesda, MD 20814**  
**[www.cpsc.gov](http://www.cpsc.gov)**

CPSC is charged with protecting the public from unreasonable risks of injury or death associated with the use of the thousands of consumer products under the agency's jurisdiction.

Many communities have enacted safety regulations requiring barriers for residential in-ground and above-ground swimming pools. In addition to following your community's laws, parents who own pools should take precautions to reduce the possibility that their youngsters will access the family pool, or a neighbor's pool or spa, without supervision. This booklet provides tips for creating and maintaining effective barriers to pools and spas.



Each year, thousands of American families suffer swimming pool tragedies. The majority of the incidents involve drownings and non-fatal drownings of young children. These pool and spa injuries and deaths involve young children, ages 1 to 3 years old, and happen in residential settings. These tragedies are preventable.

This U.S. Consumer Product Safety Commission (CPSC) booklet offers guidelines for pool barriers that can help prevent most drowning incidents involving young children. This handbook is for owners, purchasers, and builders of residential pools, spas, and hot tubs.

The swimming pool barrier guidelines are not a CPSC standard; nor are they mandatory requirements. CPSC believes that the guidelines recommended in this booklet will help make pools safer, promote pool safety awareness, and save lives. Barriers are not the sole method to prevent drowning of young children in pools; and barriers can never replace adult supervision.

Some states and localities have incorporated CPSC guidelines for safety barriers into their building codes. Check with your local authorities to see what your area's building code or other regulations require.



## Swimming Pool Barrier Guidelines

According to the Centers for Disease Control and Prevention (CDC), drowning is the leading cause of unintentional death for 1- to 4-year-old children. Each year, nearly 300 children under age 5 drown in swimming pools. Many of these young victims could be saved if homeowners fenced in their pools completely and installed gates with self-closing and self-latching devices.

Anyone who has cared for a toddler knows how fast young children can move. Toddlers are inquisitive and impulsive, and they lack a realistic sense of danger. These behaviors in children make swimming pools particularly hazardous for households with young children.

CPSC staff has reviewed a great deal of data on drownings and child behavior and studied information on pool and pool barrier construction. Staff has concluded that one of the best ways for pool owners to reduce child drownings in residential pools is to construct and maintain barriers that will help prevent young children from gaining access to pools and spas.

The CPSC guidelines suggest ways for pool and spa owners to keep children from entering the pool area unaccompanied by a supervising adult. The guidelines also consider the variety of barriers available, and the guidelines specify how each type of barrier might be susceptible to a child trying to get on the other side of the barrier and into the pool or spa.

The swimming pool barrier guidelines are presented with illustrated descriptions. The definition of a "pool" includes spas and hot tubs. Therefore, the CPSC swimming pool barrier guidelines apply to these structures, as well as to above-ground pools and, possibly, larger portable pools.

### ***Pool and Spa Submersions: Estimated Non-Fatal Drowning Injuries and Reported Drownings\****

CPSC publishes an annual report on drowning and non-fatal drowning incidents. Key findings from the 2017 report include:

- Nearly 300 children younger than 5 drown in swimming pools and spas each year, representing 77 percent of the 356 fatalities reported for children younger than 15.
- Children ages 1 to 3 years (12 months through 47 months) represented 65 percent of the reported fatalities and 61 percent of reported injuries in pools and spas.
- More than 4,400 children younger than 5 suffered non-fatal drowning injuries and required emergency department treatment.
- The majority of fatal drowning incidents and non-fatal drowning injuries involving victims younger than 5 years old occur in pools owned by family, friends, or relatives.
- Residential locations dominated incidents involving victims younger than 5 years old. Seventy-four percent of the fatalities occurred at residential pools or spas.
- Portable pools accounted for 4 percent of the total fatalities, with an average of 13 deaths per year for children younger than 15.

*\*The report presents average annual estimates for emergency department-treated injuries for 2014 through 2016, and average annual estimates for fatal drownings for 2012 through 2014, as reported to CPSC staff. The years for reported injury and fatality statistics differ due to a lag in fatality reporting.*

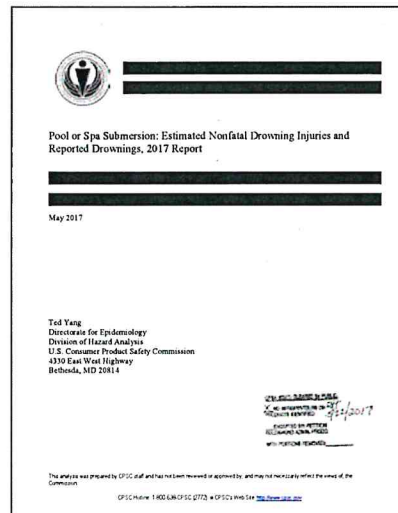

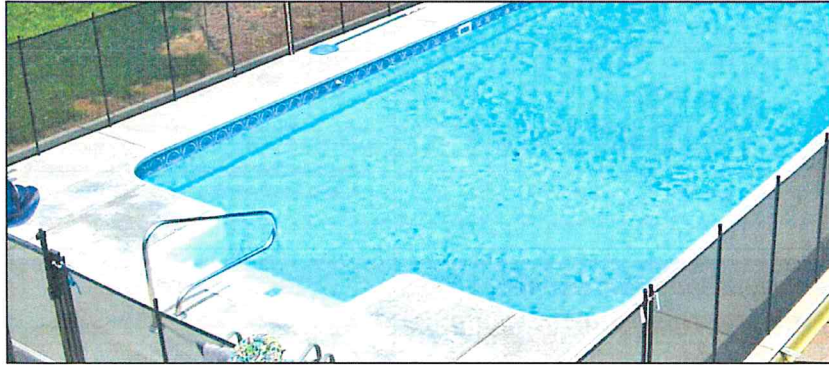

## Barriers

Barriers include a fence or wall, door alarms for the house, and a power safety cover over the pool. Barriers are not childproof, but barriers do provide layers of protection for a child when there is a lapse in adult supervision. Barriers give parents additional time to find a child before the unexpected can occur.

Use the following recommendations as a guide:

### Locations

Barriers should be located to prohibit children from using permanent structures, equipment, or similar objects to climb the barriers.

### Construction

A barrier that completely surrounds the pool is better than a fence that encloses the pool on three sides with the house serving as the fourth side of the barrier. Fences should be a minimum of 4 feet high. However, fences 5 feet or higher are preferable.

If an outside wall of the home serves as one side of the barrier, install **door alarms** on all doors leading to the pool area. Make sure the doors have self-closing and self-latching devices or locks that are beyond the reach of children. This will keep children from opening the doors and gaining access to the pool.

**Pool covers** add another layer of protection. There are a wide variety of pool cover styles on the market. Make sure that the pool cover is well maintained, and keep the control device for the pool cover out of the reach of children.

An effective pool barrier prevents a child from going **OVER, UNDER,** or **THROUGH** the barrier and keeps children from accessing the pool when supervising adults are not present.

### How to Prevent a Child from Going OVER a Pool Barrier

A young child can climb over a pool barrier if the barrier is too low or if the barrier has handholds or footholds that children can use to climb. The top of a pool barrier should be at least 48 inches above grade, measured on the exterior side of the fence or barrier. Some states, counties, or municipalities require pool barriers to be 60 inches above grade.

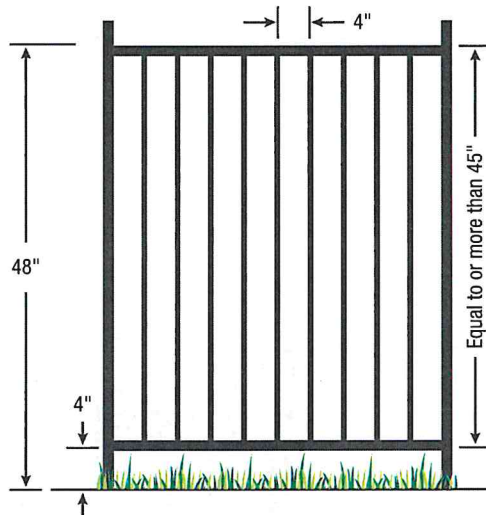

Eliminate handholds and footholds on barriers and minimize the size of openings when constructing a barrier.

Figure 1

Make sure that there are no indentations or protrusions on the barrier that may allow a child to climb over the barrier.

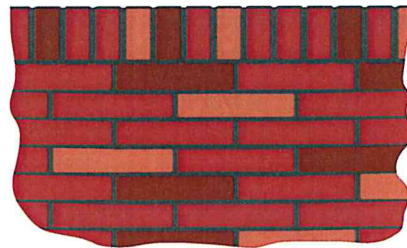

Figure 2

### For a Barrier with Horizontal and Vertical Members

If the distance between the top side of the horizontal members of the barrier or fence is less than 45 inches high, then the horizontal members should be located on the interior side of the fence.

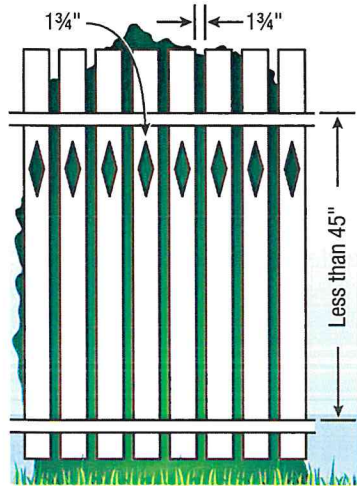

Figure 3

The spacing between vertical members and within decorative cutouts should not exceed 1 3/4 inches. This size is based on the foot width of a young child and is intended to reduce the potential for a child to gain a foothold and attempt to climb the barrier.

If the distance between the tops of the horizontal members is more than 45 inches high, the horizontal members can be located on the exterior side of the fence. The spacing between vertical members should not exceed 4 inches. This size is based on the head breadth and chest depth of a young child and is intended to prevent a child from passing through or getting stuck in an opening.

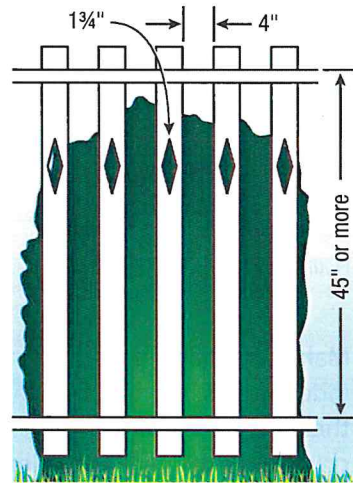

Figure 4

### For a Chain-Link Fence

The openings in the mesh of a chain-link fence should not exceed  $1\frac{3}{4}$  inches square unless slats, fastened at the top or bottom of the fence, are used to reduce the mesh openings to no more than  $1\frac{3}{4}$  inches.

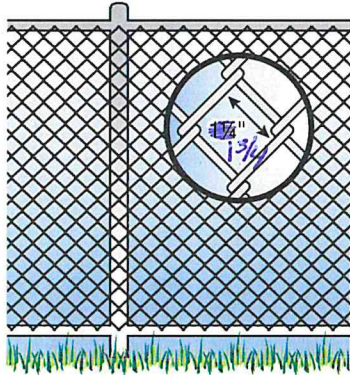

Figure 5

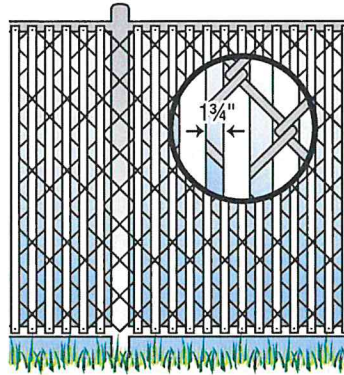

Figure 6

### For a Fence with Diagonal Members or Latticework

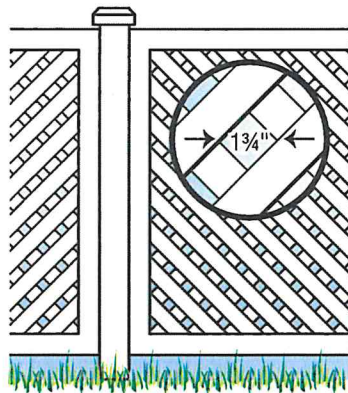

Figure 7

The maximum opening in the latticework should not exceed  $1\frac{3}{4}$  inches.

### For Above-Ground Pools

Above-ground pools should have barriers. The pool structure can serve as a barrier if the walls of the pool are high enough, or if a barrier can be mounted onto the top of the pool structure.

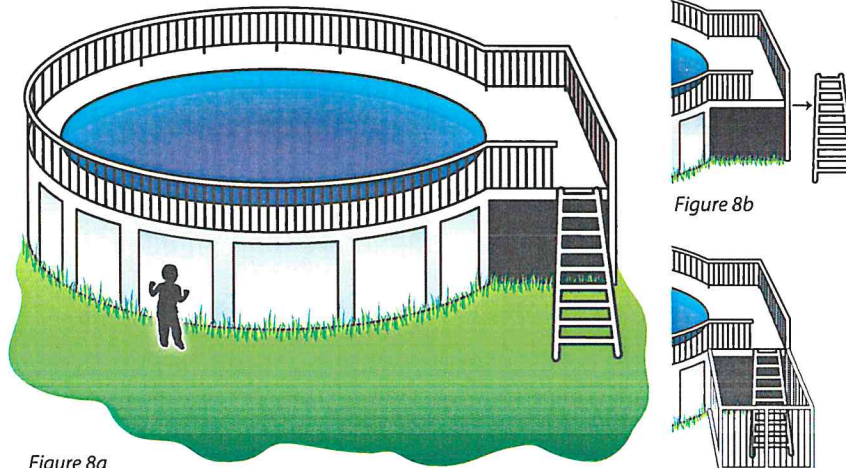

Figure 8a

Figure 8b

Figure 8c

If the pool walls are not high enough, or there are other structures close to the pool, such as a ladder or a table or a chair, often children are able to access the pool. There are ways to prevent young children from climbing and gaining access to an above-ground pool. The steps or ladder leading to the pool can be designed to be secured, locked, or removed to prevent access; or the steps or ladder can be surrounded by a barrier, such as the barriers described in these guidelines.

### Above-Ground Pool with Barrier on Top of Pool

If an above-ground pool has a barrier on top of the pool, the maximum vertical clearance between the top of the pool and the bottom of the barrier should not exceed 4 inches.

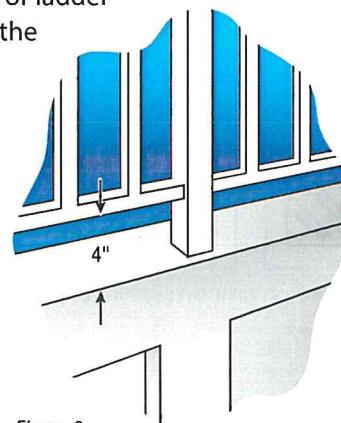

Figure 9

### How to Prevent a Child from Going UNDER a Pool Barrier

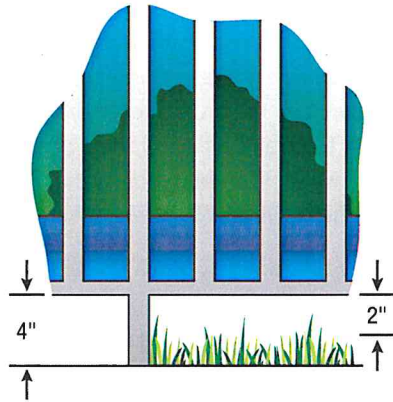

Figure 10

For any pool barrier, the maximum clearance at the bottom of the barrier should not exceed 4 inches above the surface or ground, when the measurement is done on the outside of the barrier. If the bottom of the gate or fence rests on a non-solid surface, such as grass or gravel, industry recommends that the clearance should not exceed 2 inches.

### How to Prevent a Child from Going THROUGH a Pool Barrier

To prevent a child from going through a pool barrier, restrict the size of openings in the barrier, and use self-closing and self-latching gates.

To prevent a young child from going through a fence or other barrier, make sure all openings in the barrier are small enough to prevent a 4-inch diameter sphere from passing through any opening. This size is based on the head breadth and chest depth of a young child.

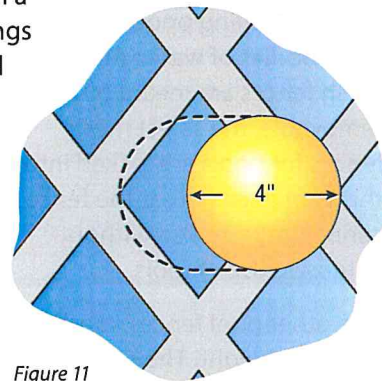

Figure 11

## Portable Pools



Portable pools are becoming more popular. Portable pools vary in size and height, from tiny blow-up pools to larger designs that can hold thousands of gallons of water. Portable pools present a real danger to young children.

Never leave children around a portable pool unsupervised. Portable pools should be fenced, covered, or emptied and stored away when not in use. Tell neighbors, friends, and caregivers that you have a portable pool and advise them of the potential dangers of a portable pool in your yard.

## Removable Mesh Fences

Mesh fences are made specifically for swimming pools or other small bodies of water. Although mesh fences are meant to be removable, the safest mesh fences for pools are locked into the pool deck so that the fence cannot be removed without extensive use of tools.



Like other pool fences, mesh fences should be a minimum of 48 inches in height. The distance between vertical support poles and the attached mesh, along with other manufactured features, should be designed to keep a child from climbing the fence. The removable vertical support posts should extend a minimum of 3 inches below grade, and they should be spaced no farther apart than 40 inches. The bottom of the mesh barrier should not be more than 1 inch above the deck or installed surface.

*For more information on Removable Mesh Fencing see ASTM standard F 2286 – 05.*

## Gates

There are several kinds of gates that might be found on a residential property: pedestrian gates and vehicle or other types of gates. Gates can be used as a swimming pool barrier. All gates should be designed with a locking device.



### Pedestrian Gates

These are gates people walk through. Swimming pool barriers should be equipped with one or more gates that restrict access to the pool.

Gates should open out from the pool and should be self-closing and self-latching. With this design, if the gate is not closed completely, a young child pushing on the gate in an effort to enter the pool area will actually be closing the gate, which may then safely latch.



Figure 12

The weak link in the strongest and highest fence is a gate that fails to close and latch completely. For a gate to close completely every time, the gate must be in proper working order.

When the release mechanism of the self-latching device on the gate is less than 54 inches from the bottom of the gate, the release mechanism for the gate should be at least 3 inches below the top of the gate on the interior side. Placing the release mechanism at this height prevents a young child from reaching over the top of a gate and releasing the latch.

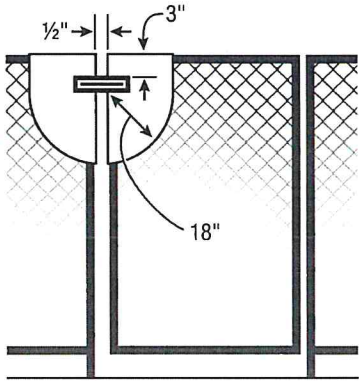
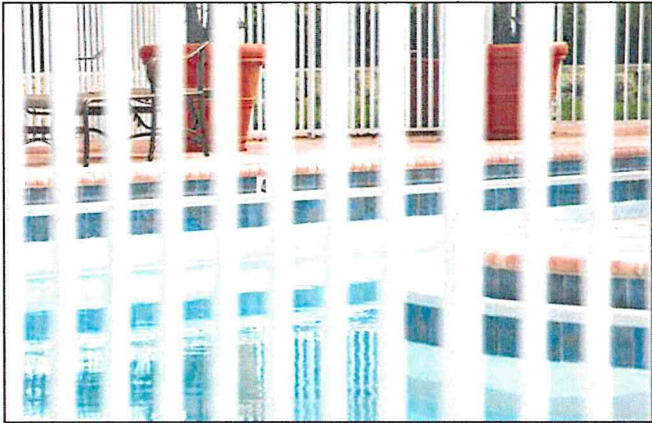

Figure 13

Additionally, the gate and barrier should have no opening greater than 1/2 inch within 18 inches of the latch-release mechanism. This prevents a young child from reaching through the gate and releasing the latch.

**All Other Gates (Vehicle Entrances)**

Other gates should be equipped with self-latching devices. The self-latching devices should be installed as described for pedestrian gates.



## When One Side of the House Forms Part of the Pool Barrier

In many homes, doors open directly from the house to the pool area or to a patio leading to the pool. In these cases, the side of the house that leads to the pool is an important part of the pool barrier. Passage through any door from the house to the pool should be controlled by security measures.

The importance of controlling a young child's movement from the house to the pool is demonstrated by the statistics obtained from the CPSC drowning reports. Incidents at residential locations dominate the accidents involving children younger than 5, accounting for 87 percent of fatalities and 54 percent of injuries (from the *CPSC 2015 Pool or Spa Submersion Report*, page 3).



Figure 14

## Door Alarms

All doors that allow access to a swimming pool should be equipped with an audible alarm that sounds when the door and/or screen are opened. Alarms should meet the requirements of *UL 2017, General-Purpose Signaling Devices and Systems, Section 77*, and have the following features:

- The alarm sound should last for 30 seconds or more and start within 7 seconds after the door is opened.
- The alarm should be loud: at least 85 dB (decibels), when measured 10 feet away from the alarm mechanism.
- The alarm sound should be distinct from other sounds in the house, such as the telephone, doorbell, and smoke alarm.
- The alarm should have an automatic reset feature to deactivate the alarm temporarily for up to 15 seconds, to allow adults to pass through house doors without setting off the alarm. The deactivation switch could be a touchpad (keypad), or a manual switch, and should be located at least 54 inches above the threshold and out of the reach of children.

Self-closing doors with self-latching devices could be used along with door alarms to safeguard doors that give access to a swimming pool.

### Pet or Doggy Doors

Never have a pet or doggy door if the door leads directly to a pool or other backyard water. An isolation barrier or fence is the best defense when pet doors are installed. Remember, pet door openings, often overlooked by adults, provide curious children with access to backyard adventures. Locking these doors is not sufficient and could lead to accidents and tragedies. Children regularly drown in backyard pools that they were able to access through pet doors. Some municipalities have building codes that prohibit doggy doors in homes with pools, unless there is an isolation fence around the pool.

### Power Safety Covers

Power safety covers can be installed on pools to provide security barriers, especially when one side of the house serves as the fourth wall or side of a barrier. Power safety covers should conform to the specifications in the *ASTM F 1346-91 standard*, which specifies safety performance requirements for pool covers to protect young children from drowning.



Figure 15

### Indoor Pools

When a pool is located completely inside a house, the walls that surround the pool should be equipped to serve as pool safety barriers. Guidelines recommended for using door alarms, pool alarms, and covers where the house wall serves as part of a safety barrier also apply for all the walls surrounding an indoor pool.

## Barriers for Residential Swimming Pools, Spas, and Hot Tubs

The CPSC pool barrier guidelines are designed to make it easier for pool owners, purchasers, builders, technicians, and others to understand and apply the guidelines to their particular properties or situations. Reading the guidelines, in conjunction with the diagrams or figures in this booklet, may be helpful. For more information, consult your local building department or code authority.

### Outdoor Swimming Pools

All outdoor swimming pools, including in-ground, above-ground, or on-ground pools, hot tubs, or spas, should have a barrier that complies with the following:

1. The **top of the barrier** should be at least 48 inches above the surface measured on the interior side of the barrier (figure 1).
2. The maximum **vertical clearance between the surface and the bottom of the barrier** should be 4 inches, measured on the exterior side of the barrier. In the case of a non-solid surface, such as grass or pebbles, the distance should be reduced to 2 inches, and 1 inch for removable mesh fences (figures 1 and 10).
3. Where the top of the **pool structure is above grade or surface**, such as an above-ground pool, the barrier may be at ground level, like the pool structure, or mounted on top of the pool structure. Where the barrier is mounted on top of the pool structure, the maximum vertical clearance between the top of the pool structure and the bottom of the barrier should be 4 inches (figure 9).
4. **Openings in the barrier** should not allow passage of a 4-inch diameter sphere (figure 11).
5. **Solid barriers**, which do not have openings, such as masonry or stone walls, should not contain indentations or protrusions that may allow a child to climb over the barrier (figure 2).
6. Where the barrier is composed of **horizontal and vertical members**, and the distance between the bottom and top horizontal members is less than 45 inches, the horizontal members should be located on the interior side of the fence (figure 3).
7. **Spacing between vertical members** should not exceed 1¾ inches in width. Where there are decorative cutouts, spacing within the cutouts should not exceed 1¾ inches in width (figure 4).
8. **Maximum mesh size for chain link fences** should not exceed 1¼ inch square, unless the fence is provided with slats fastened at the top or the bottom that reduce the openings to no more than 1¾ inches (figures 5 and 6).
9. Where the barrier is composed of **diagonal members**, such as a lattice fence, the maximum opening formed by the diagonal members should be no more than 1¾ inches (figure 7).
10. **Access gates** to the pool should be equipped with a locking device. Pedestrian access gates should open outward, away from the pool, and should be self-closing and have a self-latching device (figure 12). Gates other than pedestrian access

- gates should have a self-latching device. Where the release mechanism of the **self-latching device** is located less than 54 inches from the bottom of the gate,
- (a) the release mechanism should be located on the interior side of the gate, at least 3 inches below the top of the gate; and
  - (b) the gate and barrier should have no opening greater than ½ inch within 18 inches of the release mechanism (figure 13).
11. Where a **wall of a dwelling** serves as part of the barrier, one of the following should apply:
- (a) **All doors of a home that provide direct access to the pool** should be equipped with an **alarm** that produces an audible warning when the door and its screen, if present, are opened. Alarms should meet the requirements of *UL 2017, General-Purpose Signaling Devices and Systems, Section 77*. For more details on alarms, see page 13.
  - (b) The pool should be equipped with a **power safety cover** that complies with ASTM F1346-91, listed below.
  - (c) Other means of protection, such as **self-closing doors with self-latching devices**, are acceptable, as long as the degree of protection afforded is not less than the protection afforded by (a) or (b), described above.
12. Where an **above-ground pool structure is used as a barrier**, or where the barrier is mounted on top of the pool structure, and the means of access is a ladder or steps (figure 8a), then
- (a) **the ladder** to the pool or steps should be capable of being secured, locked, or removed to prevent access (figure 8b); or
  - (b) **the ladder or steps should be surrounded by a barrier** (figure 8c). When the ladder or steps are secured, locked, or removed, any opening created should not allow the passage of a 4-inch diameter sphere.

### For more information on

#### Fencing:

- **ASTM F 1908-08** *Standard Guide for Fences for Residential Outdoor Swimming Pools, Hot Tubs, and Spas*: <http://www.astm.org/Standards/F1908.htm>
- **ASTM F 2286-05** *Standard Design and Performance Specifications for Removable Mesh Fencing for Swimming Pools, Hot Tubs, and Spas*: <http://www.astm.org/Standards/F2286.htm>

#### Covers:

- **ASTM F 1346-91** *Standard Performance Specification for Safety Covers and Labeling Requirements for All Covers for Swimming Pools, Spas and Hot Tubs*: <http://www.astm.org/Standards/F1346.htm>

Note: ASTM Standards are available for a fee. You may want to contact a pool contractor.

#### Standards:

- **ASTM Standards**: Contact ASTM online at: <http://www.astm.org/CONTACT/index.html>.
- **UL** (Underwriters Laboratories) Relevant Pool and Spa Standards <http://www.ul.com>. Look for Life Safety and Security Product



The CPSC **Pool Safely: Simple Steps Save Lives campaign** provides advice and tips on drowning and entrapment prevention. Installing barriers is just one of the *Pool Safely* Simple Steps for keeping children safe around all pools and spas. Here are others:

## **Rule # 1: Never leave a child unattended around a pool, spa, bath tub, or other body of water.**

### **At pools, spas, and other recreational waters:**

- Teach children basic water safety skills.
- Learn how to swim and make sure your children know how to swim.
- Avoid entrapment accidents by keeping children away from pool drains, pipes, and other openings.
- Have a phone nearby at all times when visiting a pool or spa.
- Know the address of your location so that you can direct emergency personnel to the scene, if needed.
- If a child is missing, look for the child in the pool or spa first, including neighbors' pools or spas.
- Share safety instructions with family, friends, babysitters, and neighbors.

### **If you have a pool:**

- Install a 4-foot non-climbable fence around the perimeter of the pool and spa, including portable pools.
- Use self-closing and self-latching gates. Ask neighbors to do the same if they have pools or spas.
- If the house serves as the fourth side of a fence around a pool, install and use a door or pool alarm and/or a pool or spa cover.
- Maintain pool and spa covers in good working order.
- Ensure that any pool or spa that you use has anti-entrapment safety drain covers. Ask your pool service representative if you do not know.\*
- Have life-saving equipment—such as life rings, floats, or a reaching pole—available and easily accessible.

*\*The Virginia Graeme Baker Pool & Spa Safety Act, a federal law, requires all public pools and spas to have anti-entrapment drain covers and other devices, where needed. Residential pools are not required to install these, but they are highly recommended.*

Visit [www.PoolSafely.gov](http://www.PoolSafely.gov) for more information. See the most recent CPSC submersion reports: *2012-2016 Reported Circulation/Suction Entrapment Incidents Associated with Pools, Spas, and Whirlpool Bathtubs, 2017 Report and Pool or Spa Submersion: Estimated Nonfatal Drowning Injuries and Reported Drownings, 2017 Report.*

U.S. Consumer Product Safety Commission  
4330 East West Highway  
Bethesda, MD 20814

**Twitter:** @poolsafely

[www.PoolSafely.gov](http://www.PoolSafely.gov)

**Email:** [poolsafely@cpsc.gov](mailto:poolsafely@cpsc.gov)